

# 48 VOLT CONNECTORS

Designed for **the future of mobility**





# At Aptiv, we are **born to move**

Aptiv is a global technology company that develops safer, greener and more connected solutions enabling a more sustainable future of mobility. Headquartered in Dublin, Aptiv has 200,000 employees and operates 11 technical centers, as well as manufacturing sites and customer support centers, in 48 countries.

VISIT [APTIV.COM](https://www.aptiv.com)



## Why switch to 48 volt now?

### SAME POWER WITH LESS COPPER

Automakers are increasingly building 48V electrical architectures into their vehicles to take advantage of key benefits, including more efficient power delivery, and weight and mass reductions.

The move to 48V is a natural evolution for automotive. Most cars made before 1950 used 6V electrical systems. The industry transitioned to 12V by the mid-1950s as copper prices rose and cars added more control circuits, motors and electronic devices. Doubling the voltage halves the amount of current required, which means that less copper is needed to deliver the same power.

Today's vehicles are full of high-current devices requiring heavy and expensive copper wiring. Increasing the supply voltage reduces the current, so wiring can be downsized.

48V architectures are optimal because, even in overvoltage conditions, the voltage will remain below the safe "low voltage" limit of 60V.

Automotive Low-Voltage Architecture Increase in Current (A) Through the Decades

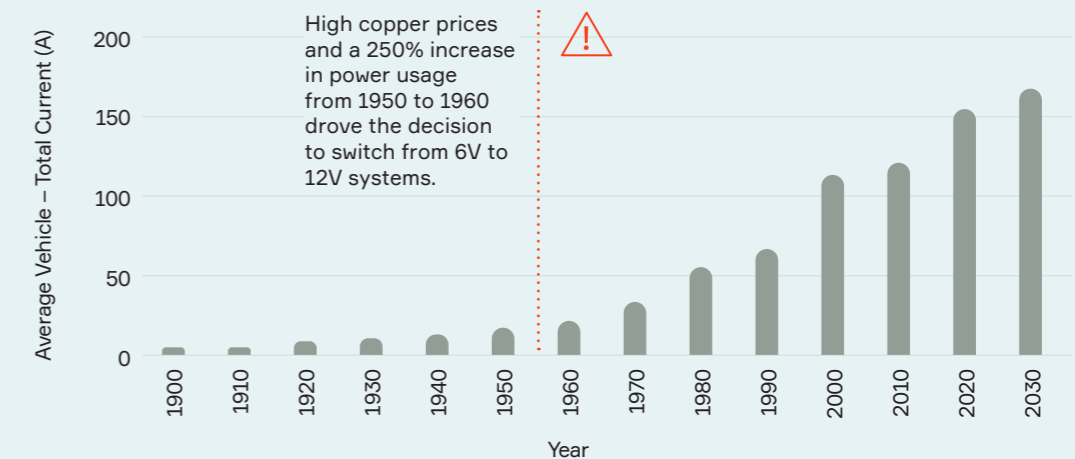



## Benefits of Switching from 12V to 48V

The 48V Sweet Spot

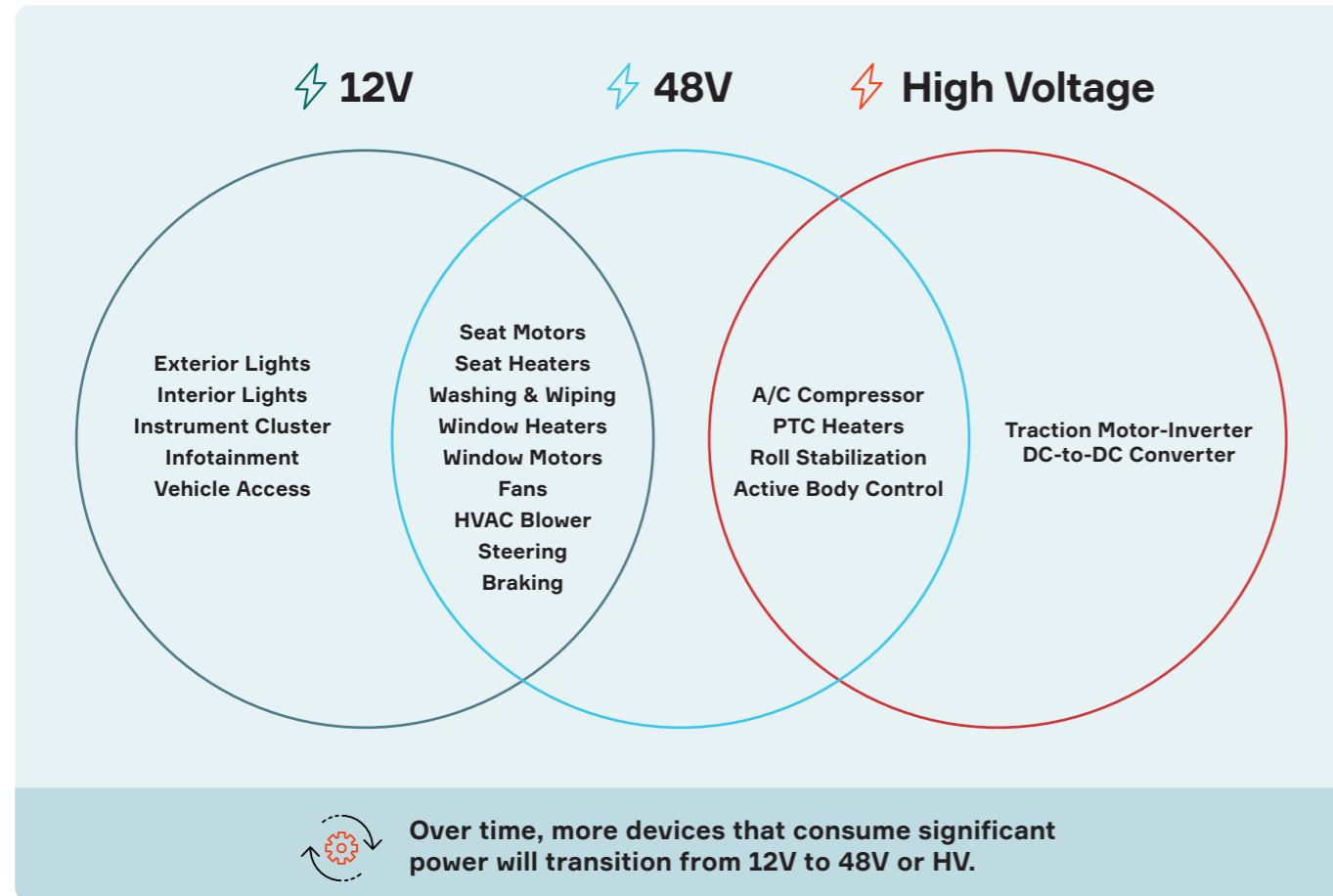

## Advantages of switching from 12V to 48V architectures:

- **Reduces current by a factor of four** to deliver the same power to a device ( $P = V \times I$ )
- Enables **weight and package size reductions** due to smaller wires, terminals, connectors and devices associated with lower current
- **Increases range and lowers CO<sub>2</sub> emissions** because of the weight reduction
- Increases **power delivery efficiency**, as the lower current means resistive losses can be reduced by up to a factor of 16 ( $P = I^2 \times R$ )
- Ensures **proper voltage at the device**, since lower currents reduce the voltage drop along wires ( $V = I \times R$ )
- Enables motors and other electrical components to be made with **less copper**
- Puts **less stress on batteries** during engine starts for internal combustion engine and hybrid vehicles
- Enables **higher-torque starters** for higher-compression engines and mild hybrids

## 48V Challenges

AVOID PITFALLS BY FOLLOWING GUIDELINES

There are several factors to keep in mind when it comes to designing vehicles with 48V architectures:

- Circuits must be properly isolated and grounding guidelines followed to avoid interference and possible damage to devices.
- The risk of electrochemical corrosion increases with high-voltage potential across terminals in a connector exposed to an electrolyte.
- Clearance guidelines must be followed for header and connector designs, to prevent arcing and creepage.
- Hot disconnects must be mitigated.

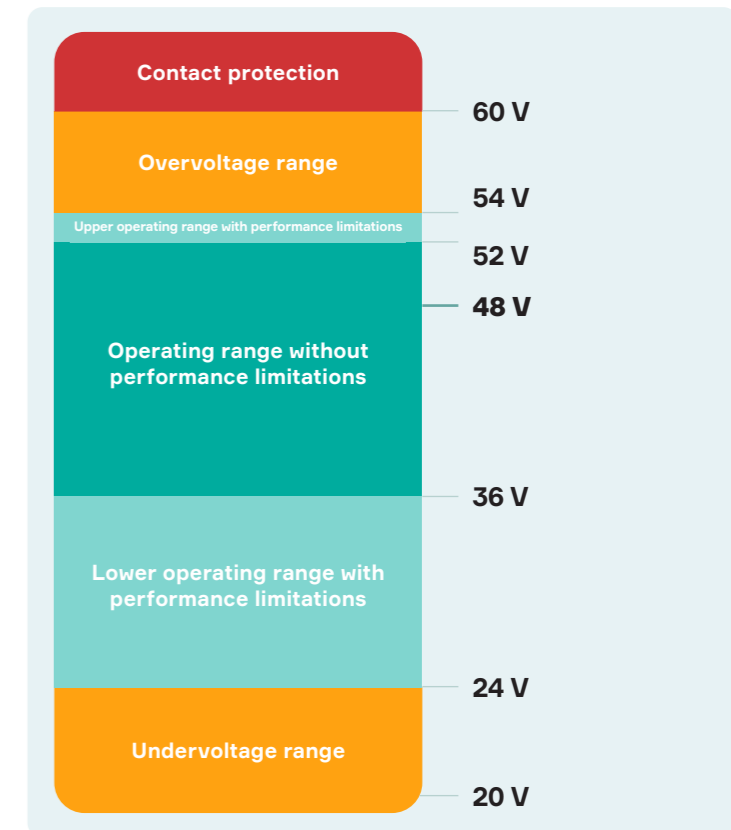

## Aptiv's Approach

Aptiv offers connectors that are built to address these challenges. We recommend:

- Avoiding the use of 12V and 48V in the same connector. If an application dictates using both voltages, our connectors can provide walls between the voltages.
- Using sealed connectors wherever there is a risk of spill or contamination.
- Using device headers and connectors that meet creepage and clearance requirements, protecting for 60V (overvoltage).
- Employing terminal secondary locking in connectors to eliminate all risk of terminal pull outs.
- Using proven, robust terminal systems to avoid intermittent contacts.

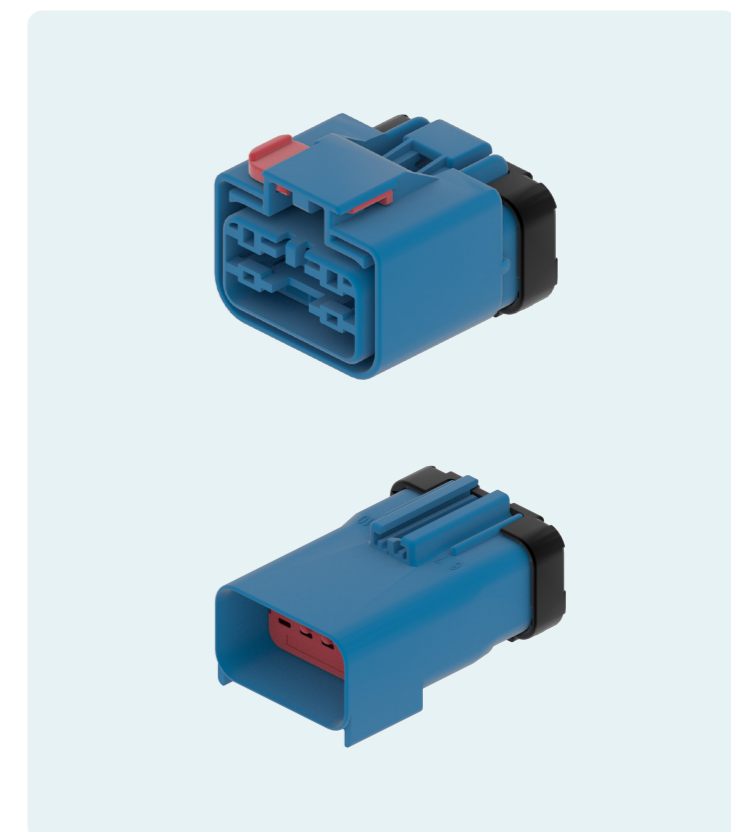

# Table of Contents

## Connectors and Terminals

- CTS 1.2 SensoMate™ Series 8
- CTS 1.2 Female and OCS 1.2 Male Locking Lance Sealed Series 10
- APEX® 2.8 Sealed Series 12
- APEX® 2.8 Terminals 14
- POWERPACK 48V Sealed Ring Connector 1 Way 16
- POWERPACK LV 1000 1 and 2 Way 18
- POWERPACK LV 2000 Inline Connector 1 Way 20

## Selector Guide

Aptiv offers a wide range of 48V products for various applications. Please see the table below for an overview of the products featured in this catalog and the pages where you can find further information.

- CTS 1.2 SensoMate and APEX 2.8 Sealed connectors are made in blue to indicate 48V and support lower-power and signal applications.
- Sealed ring terminals provide a simple connection strategy for power applications.
- PowerPack LV connectors offer a connector solution for power applications, complete with Connector Position Assurance.



Product Series	CTS 1.2 SensoMate	APEX 2.8 Sealed	PowerPack 48V Sealed Ring Connector	PowerPack LV 1000 Connector	PowerPack LV 2000 Connector
Application	Chassis, engine compartment, on-engine mount, severe gearbox applications, sensors/actuators	On-engine sensors	48V electrical centers, power distribution boxes, start-stop systems, e-turbo, battery, active suspension, BSG units	High-current harnesses and devices, sealed pass-through panel mount systems	High-current harnesses and devices, sealed pass-through panel mount systems
No. of Cavities	2, 3, 4, 5, 6	2, 3, 4, 6, 10, 14	1	1, 2	1
Gender	F, M (2 to 4)	F, M	F	F, M, Header	F, M
Current at 85° C	18A	40A	250A	120A	210A
Temperature	- 40 to + 150° C	- 40 to + 150° C	- 40 to + 125° C	- 40 to + 125° C	- 40 to + 125° C
CPA (Connector Position Assurance)	Yes	Optional	No	Yes	Yes
See Pages	8	12	16	18	20

# CTS 1.2 SENSOMATE™ SERIES

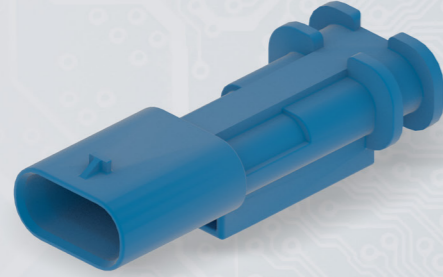

OCS 1.2 3W Male

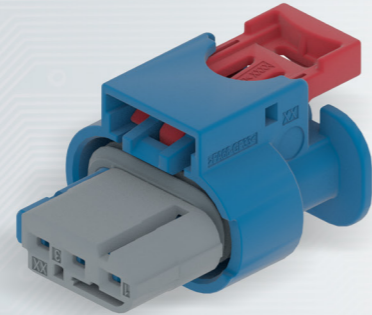

CTS 1.2 3W Female

## BENEFITS

- VDA/USCAR 1.2 mm at 4 mm, pitch interface compatible (universal)
- Industry standard 1.2 terminal cavity capability
- Short shroud design for small packaging footprint

## FEATURES

- One-piece molded housing to ensure best-in-class sealing performance
- Patented Smart Locking System version of the CPA to improve assembly cycle time
- Compatible with wire dress backshells
- Inline system uses a male OCS 1.2 blade to mate to CTS 1.2 female connector

## APPLICATIONS

Chassis, engine compartment, on-engine mount, severe gearbox applications, sensors/actuators

## PERFORMANCE

### Temperature

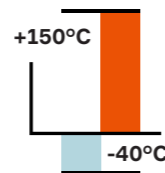

### Vibration level

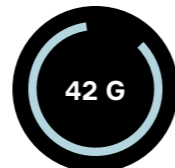

sine on short shroud versions

### Sealing class



### Max voltage



## AVAILABLE CONFIGURATIONS

Cavity Count (ways)	2, 3, 4, 5, 6
Cavity Configurations (mm)	1.2
Genders	Female, Male (2-4 ways only)
Sealing Type	Cable Sealed
Centerline Spacing (mm)	4.0
Indexes	Varies; see part list
TPA Type	Independent Secondary Lock (ISL)
CPA	Yes
Validation	GMW 3191; RNDS-B-00029 V.2 for short shroud; others, please contact us

Cavity count	Blade Size (mm)	Gender	Dimensions W x H x D (mm)	Part Number	Index	Color	Terminal Type	Other Indexes Offered
2	1.2	F	15.2 x 15 x 29.5	35834329	A	Blue	CTS	B, C
3	1.2	F	19.2 x 15 x 29.5	35834330	A	Blue	CTS	B, C, D
4	1.2	F	24.5 x 16.3 x 29.5	35834331	A	Blue	CTS	B, C, D, F, G
5	1.2	F	28.5 x 16.3 x 29.5	35834332	A	Blue	CTS	B
6	1.2	F	32.5 x 16.3 x 29.5	35834333	A	Blue	CTS	B, C, E
2	1.2	M	18.8 x 15.4 x 46.8	35865258	A	Royal Blue	OCS	B, C, USCAR* E, F
3	1.2	M	18.8 x 15.4 x 46.8	35865259	A	Royal Blue	OCS	B, C, D
4	1.2	M	24.1 x 16.5 x 46.8	35865260	A	Royal Blue	OCS	B, C, USCAR* E, F, G

\*USCAR interface on device

## COMPATIBLE SEALS AND ACCESSORIES

Type	Applicable Wire Size (mm <sup>2</sup> )	Color	Restraint Ring	Part Number
Cable Seal	0.13 - 0.35	Black	No	33120594
Cable Seal	0.35 - 0.5	Red	No	15327913
Cable Seal	0.5 - 1.0	Gray	No	15327918
Cable Seal	1.0 - 1.25	Yellow	No	15339412
Cavity Plug	NA	White	No	12198198
Cable Seal	0.13 - 0.35	Yellow	Yes	13887349
Cable Seal	0.5 - 1.0	Green	Yes	13887350
Cavity Plug	NA	Blue	Yes	13887353
Fixing Clip for Male Housing Slot**	NA	Black	NA	33119512
Backshell***	NA	-	NA	Contact us

Other cable seals and cavity plugs available; please contact us  
 \*\* USCAR 7 mm  
 \*\*\*Lateral 90°, up/down 90°, 0°

## COMPATIBLE WITH



OCS 1.2 Locking Lance Sealed Terminal

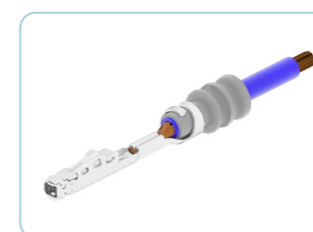

CTS 1.2 Female Locking Lance Sealed Terminal

## EXPLODED VIEW

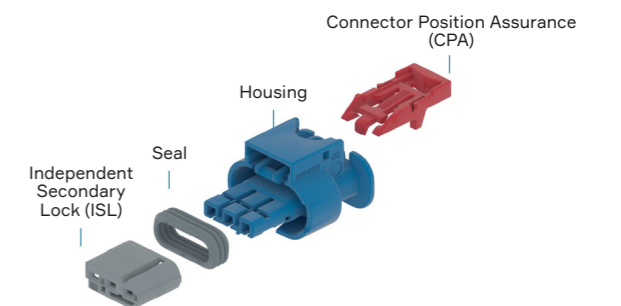

CTS 1.2 3W F

# CTS 1.2 FEMALE AND OCS 1.2 MALE LOCKING LANCE SEALED SERIES

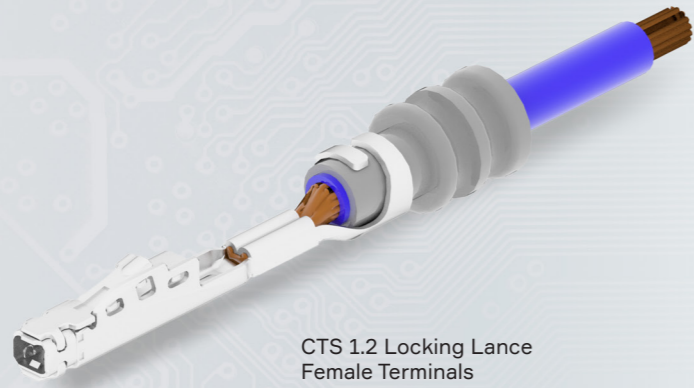

CTS 1.2 Locking Lance Female Terminals

## BENEFITS

- Compatible with industry standard cavities
- Robust terminal design with several design features, providing a perfect electrical function for two different tab thicknesses in one part
- 100% vision-controlled manufacturing

## FEATURES

- Protected mating area
- One robust primary locking lance
- High-performance copper alloy
- Shape inside: four electrical contact points
- Ultrasonic welding ability according to AK 43-2
- OCS male blade mates to CTS female terminal

## TECHNICAL CHARACTERISTICS

Contact Resistance	2.5 mΩ
Contact Mating Force	4.2 N
Contact Unmating Force	4.2 N
Mating Cycles	20 (Sn) / 30 (Ag)
Center Line Spacing	Unsealed: 2.5 x 2.5 mm Sealed: 4.5 x 4.5 mm

<p><b>Max temperature</b></p> <p>170° C Ag</p>	<p><b>Max current at 23° C</b></p> <p>18.7A up to 48V</p>	<p><b>Max vibration level</b></p> <p>30 G sine on short shroud versions</p>
--	---	---

## AVAILABLE CONFIGURATIONS

Terminal Construction	Two-piece female
Locking Mechanism	Tanged/Lanced
Crimp Validated To	LV214
Blade Size (mm)	1.2
Wire Gage Range (AWG)	24 - 16
Wire Gage Range (mm <sup>2</sup> )	0.13 - 1.0
Sealing Options	Cable Sealed
Plating Options	Sn, Ag
Mating Tab Dimension (mm)	1.2 x 0.6 (up to 0.64)

Sealing	Gender	Plating	Wire Size Range (AWG)	Wire Size Range (mm <sup>2</sup> )	Part number	Other Available Platings
Cable Sealed	F	Sn	24	0.13	13959117	Ag, Au
Cable Sealed	F	Sn	22	0.20 - 0.35	13959120	Ag, Au
Cable Sealed	F	Sn	20	0.50 - 0.75	13959141	Ag, Au
Cable Sealed	F	Sn	18 - 16	1.0	13948568	Ag, Au
Cable Sealed	M	Sn	21	0.35 - 0.5	35383357	Ag
Cable Sealed	M	Sn	18	0.75 - 1.0	35383355	Ag

## COMPATIBLE SEALS

Type	Gender	Applicable Wire Size (mm <sup>2</sup> )	Color	Restraint Ring	Part Number
Cable Seal	F	0.13 - 0.35	Yellow	Yes	13887349
Cable Seal	F	0.5 - 1.0	Green	Yes	13887350
Cavity Plug	F	N/A	Blue	Yes	13887353
Cable Seal	M	0.35 - 0.5	Red	No	15327913
Cable Seal	M	0.5 - 1.0	Gray	No	15327918
Cavity Plug	M	N/A	White	No	12198198

Please contact an Aptiv representative for the full part number list.

## DERATING CURVES

Cable range: 0.13 - 1.5 mm<sup>2</sup>  
 Crimp method: Standard  
 Contact plating: Sn  
 Test method: Single circuit in free air\*  
 Mated to: MLK 120 Sn

\* For reference only

Terminal without housing

acc. to DIN EN 60512-5-2

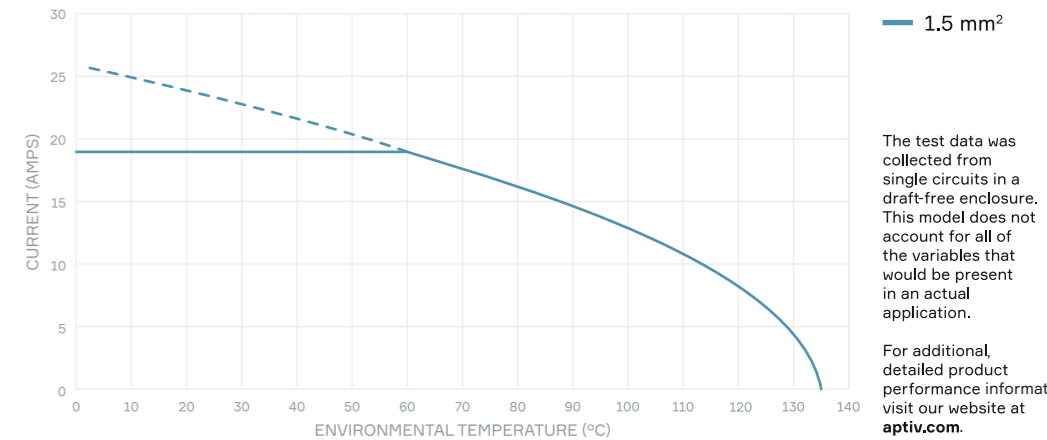



# APEX® 2.8 SEALED SERIES

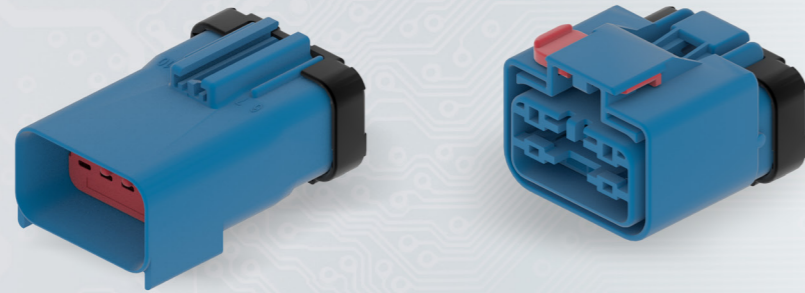

APEX® 2.8 Sealed 10W Female & Male

## BENEFITS

- Heavy-duty performance
- Highest current rating
- Ergonomic design

## FEATURES

- Most compact 2.8 mm system in the industry
- Fully protected interface seal
- Meets or exceeds USCAR performance standards and GMW3191
- Compliant with USCAR design guidelines and performance standards
- 0.75 mm<sup>2</sup> (20 AWG) to 4 mm<sup>2</sup> (10 AWG)
- Primary Lock Reinforcement (PLR)
- Mechanical polarization

## APPLICATIONS

Sealed inline and device applications

## PERFORMANCE

### Temperature

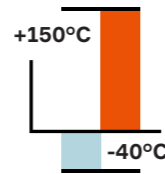

### Vibration level

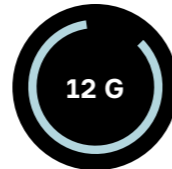

### Sealing class



### Max voltage



## AVAILABLE CONFIGURATIONS

Cavity Count (ways)	2, 3, 4, 6, 10, 14
Cavity Configurations (mm)	2.8
Genders	Female, Male
Sealing Type	Mat Sealed
Centerline Spacing (mm)	5.25

Cavity Count	Blade Size (mm)	Gender	Dimensions W x H x D (mm)	Part Number	Index	Color	Other Indexes Offered
2	2.8	F	24.8 x 25.7 x 40.1	35838342	A	Royal Blue	B, C, D
2	2.8	M	21.9 x 23.4 x 53.0	35827288	A	Royal Blue	B, C, D
3	2.8	F	28.2 x 21.9 x 40.1	35834937	A	Royal Blue	B, C, D
3	2.8	M	28.2 x 22.5 x 53.0	35834947	A	Royal Blue	B, C, D
4	2.8	F	32.6 x 22.2 x 40.1	35827352	A	Royal Blue	B, C, D
4	2.8	M	31.1 x 22.5 x 53.0	35827356	A	Royal Blue	B, C, D
6	2.8	F	24.8 x 25.3 x 37.7	35827333	A	Royal Blue	B, C, D
6	2.8	M	24.4 x 26.3 x 53.0	35827870	A	Royal Blue	B, C, D
10	2.8	F	35.3 x 31.4 x 40.1	35827363	A	Royal Blue	B, C, D
10	2.8	M	32.4 x 29.1 x 53.0	35827367	A	Royal Blue	B, C, D
14	2.8	F	45.8 x 30.8 x 37.8	35827369	A	Royal Blue	B, C, D
14	2.8	M	46.2 x 29.2 x 53.1	35831205	A	Royal Blue	B, C, D

Please contact an Aptiv representative for the full part number list.

## COMPATIBLE SEALS

Type	Color	Restraint Ring	Part Number
Cavity Plug	Blue	Yes	35478080
Cavity Plug	White	No	15305170

## DIMENSIONS MEASUREMENT SAMPLE

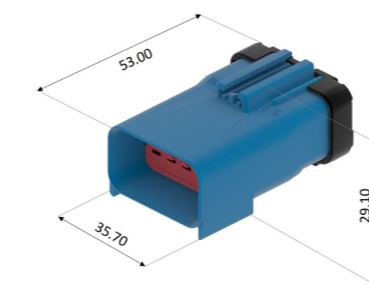

APEX® 2.8 Sealed 10W Male

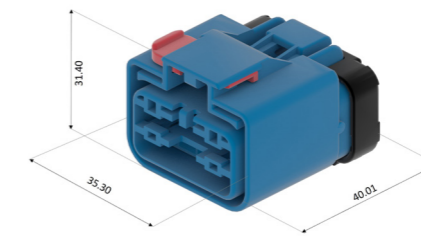

APEX® 2.8 Sealed 10W Female

## COMPATIBLE WITH



APEX® 2.8 Series

## EXPLODED VIEW

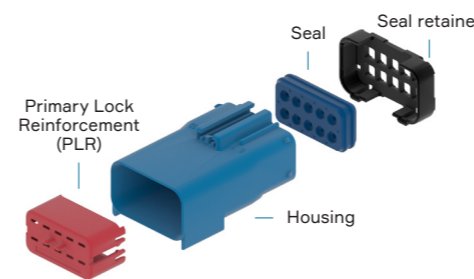

APEX® 2.8 Sealed 10W Male

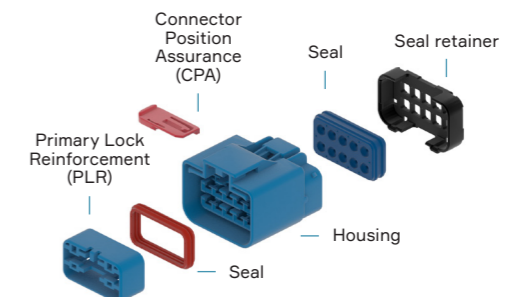

APEX® 2.8 Sealed 10W Female

# APEX® 2.8 TERMINALS



## ✓ BENEFITS

- Heavy-duty performance
- Highest current rating

## ⚙️ FEATURES

- Two-piece construction
- Integrated floating spring made of beryllium copper or copper nickel silicon
- Low contact mating force

## TECHNICAL CHARACTERISTICS

Contact Resistance	< 2 mΩ
Contact Mating Force	< 5 N
Contact Unmating Force	< 2 N

Max temperature	Max current at 23° C	Max vibration level
-----------------	----------------------	---------------------



## AVAILABLE CONFIGURATIONS

Terminal Type	Box & Blade
Terminal Construction	Two-piece
Locking Mechanism	Tangless / Lanceless
Terminal Cavity	APE®
Blade Size (mm)	2.8
Wire Gage Range (AWG)	22 - 10
Wire Gage Range (mm²)	0.35 - 6.0
Genders	Female, Male
Sealing Options	Unsealed, Mat Sealed
Plating Options	Sn, Au

Sealing	Gender	Plating	Wire Size Range (AWG)	Wire Size Range (mm²)	Part Number	Other Available Platings	Other Available Configurations
Unsealed/Mat Sealed	F	Sn	12 - 10	4.0 - 6.0	10762802	Au	Greased/Ungreased, Rewind A, C
Unsealed/Mat Sealed	F	Sn	12	3.0	15422738	Au	Greased/Ungreased, Rewind A, C
Unsealed/Mat Sealed	F	Sn	16 - 14	2.0	10762803	Au	Greased/Ungreased, Rewind A, C
Unsealed/Mat Sealed	F	Sn	20 - 18	0.5 - 1.0	10757690	Au	Greased/Ungreased, Rewind A, C
Unsealed/Mat Sealed	F	Sn	22	0.35	10757691	-	Greased/Ungreased, Rewind A, C
Unsealed/Mat Sealed	M	Sn	12 - 10	4.0 - 6.0	10762774	Au	Rewind A, C
Unsealed/Mat Sealed	M	Sn	16 - 14	1.5 - 2.5	10757692	Au	Rewind A, C
Unsealed/Mat Sealed	M	Sn	20 - 18	0.5 - 1.0	10762775	Au	Rewind A, C
Unsealed/Mat Sealed	M	Sn	22	0.35	10762776	Au	Rewind A, C

## ↑ TEMPERATURE RISE CURVE

### APEX® 2.8 FEMALE TERMINAL

Aptiv taxi: 15324842  
 Cable range: 0.35 - 6.0 mm²  
 Crimp method: Standard  
 Contact plating: Sn  
 Test method: Single circuit in free air\*  
 Mated to: Male terminal

\* For reference only

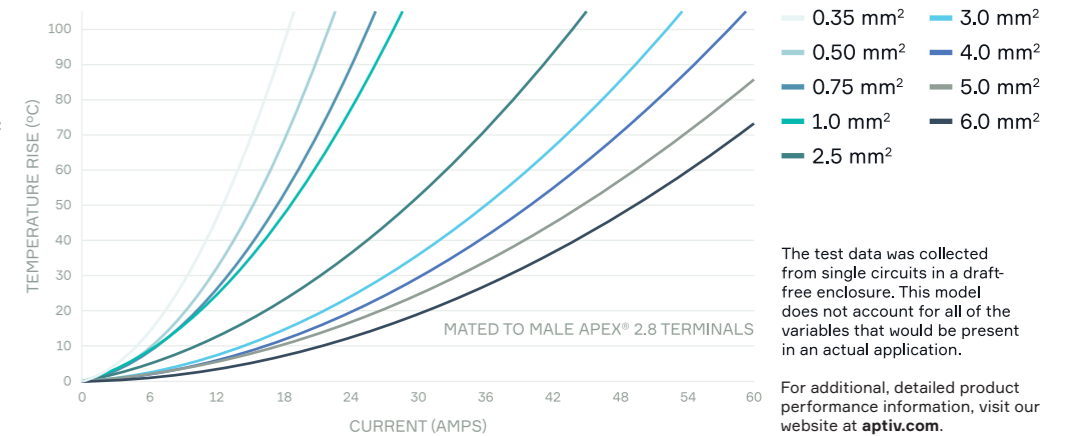



# POWERPACK 48V SEALED RING CONNECTOR 1 WAY



## BENEFITS

- Fast and easy assembly process
- High robustness against vibrations
- High current carrying capabilities

## FEATURES

- Ideal solution for 12V to 48V requiring sealed ring connections
- Can be screwed from the top
- Header interface available for system supplier integration on the box
- M8 ring terminal bolted to device

## APPLICATIONS

48V electrical centers, power distribution boxes, start-stop systems, e-turbo, battery, active suspension, bsg units

## PERFORMANCE

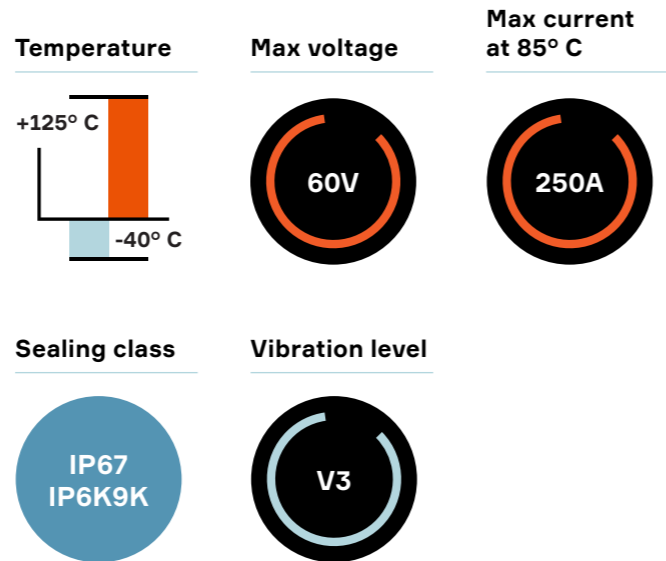

## AVAILABLE CONFIGURATIONS

Connector Type	Wire-to-device
Cable Exit Orientation	90°
Cable Range (mm <sup>2</sup> )	35, 50
Terminal Type	M8 ring terminal
Number of Power Terminals	1
Shielding Type	Unshielded
HVIL	None
Assembly Assurance	None
Number of Indexes	2

Code	Mating Connector	Header Connector	BOM
A	33376962	Please contact your Aptiv representative for more information	1
B	33376953	Please contact your Aptiv representative for more information	1

## ASSOCIATED PARTS

Part Number	Type	Applicable Wire Size (mm <sup>2</sup> )	Cable Type	BOM
33376821	Single wire seal retainer	35 - 50	-	2
33329995	M8 O-ring terminal	35 - 50	-	1
35093138	Single wire seal	35	Unshielded	1

## DIMENSIONS MEASUREMENT SAMPLE

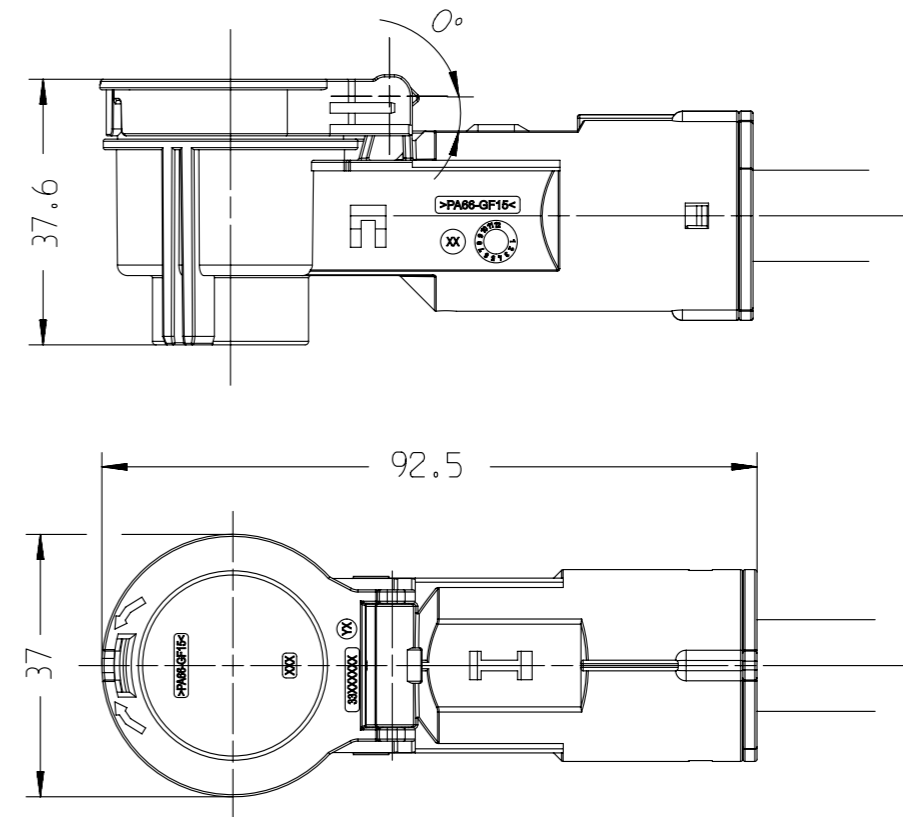

33376962

# POWERPACK LV1000 1 AND 2 WAY



1 Way Inline Connectors

2 Way Inline Connectors

2 Way Device and Pass-Through Connectors

## BENEFITS

- High current carrying capacity
- Proven terminal system
- Compact system design
- Field-proven in both automotive and heavy-duty applications

## FEATURES

- Silver-plated multi-contact terminal system
- Sealed panel mount pre-stages prior to fastening
- Panel mount secured in place with self-tapping screws
- Pass-through connection accepts both straight and right-angle connectors

## APPLICATIONS

High-current harnesses and devices, sealed pass-through panel-mount systems

## PERFORMANCE

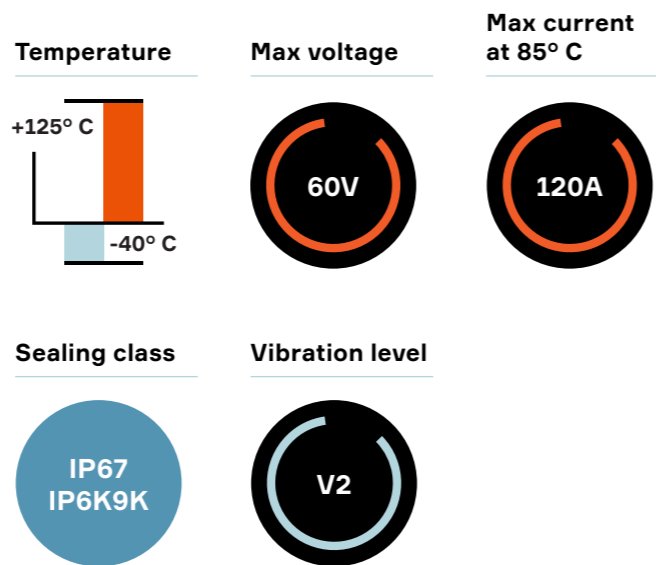

## AVAILABLE CONFIGURATIONS

Connector Type	Wire-to-device, wire-to-wire, pass-through
Cable Exit Orientation	180°, 90°
Cable Range (mm <sup>2</sup> )	8 - 25
Terminal Type	Power Pack 1000
Number of Power Terminals	1 or 2
Shielding Type	Unshielded
HVIL	None
Assembly Assurance	None
Number of Indexes	2

## 1 WAY INLINE CONNECTORS

Male Connector	Mating Connector	BOM
13882980	13952702	1

## 2 WAY INLINE CONNECTORS

Index	Male Connector	Mating Connector	BOM
103	13849747	13849756	1
104	13849748	13849757	

## 2 WAY DEVICE AND PASS-THROUGH CONNECTORS

Index	Header Connector	Mating Connector		BOM
		180°	90°	
103	13959824	13849756	13849758	1

## ASSOCIATED PARTS

Part Number	Description	BOM
<b>Header/Male inline</b>		
13675577	PP1000 silver-plated 8 - 10 mm <sup>2</sup>	1
13675579	PP1000 silver-plated 19 - 25 mm <sup>2</sup>	
<b>Mating connector</b>		
13675583	PP1000 silver-plated 8 - 10 mm <sup>2</sup>	1
13675585	PP1000 silver-plated 19 - 25 mm <sup>2</sup>	
<b>Seals and Retainers*</b>		
13675510	Cable seal PP1000 4.54 - 5.79 dia cable (gray) 8 - 10 mm <sup>2</sup>	1
13675513	Cable seal PP1000 1.01 - 9.19 dia cable (blue) 19 - 25 mm <sup>2</sup>	
13849785	Cable seal retainer PP1000 8 - 10 mm <sup>2</sup>	1
13849788	Cable seal retainer PP1000 19 - 25 mm <sup>2</sup>	

## DIMENSIONS MEASUREMENT SAMPLE

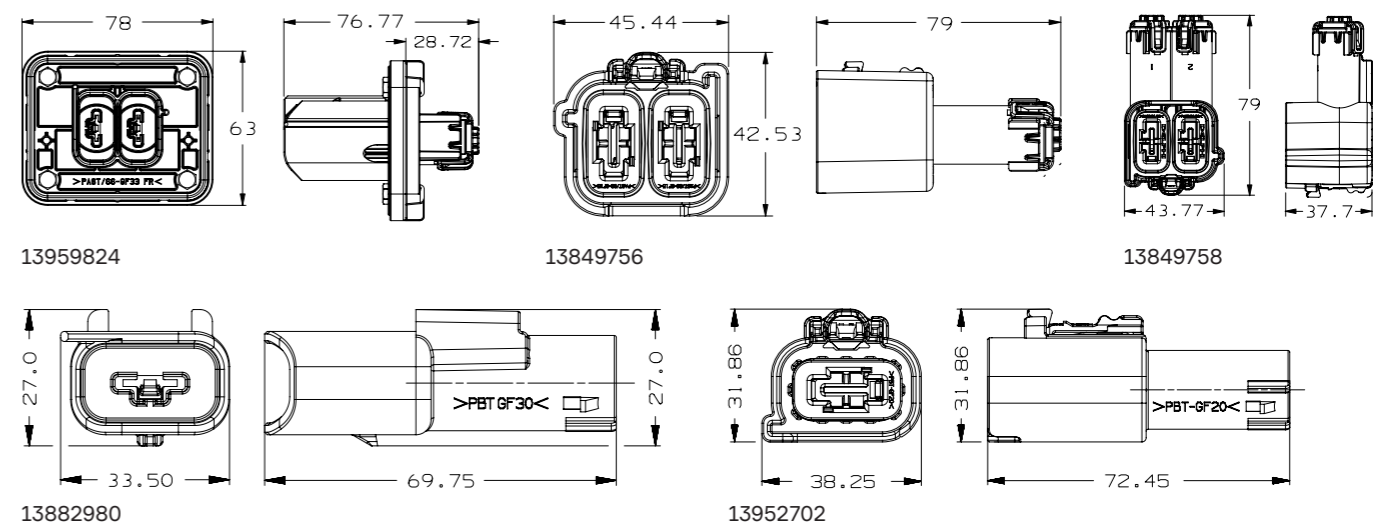



# LV 2000 INLINE CONNECTOR 1 WAY

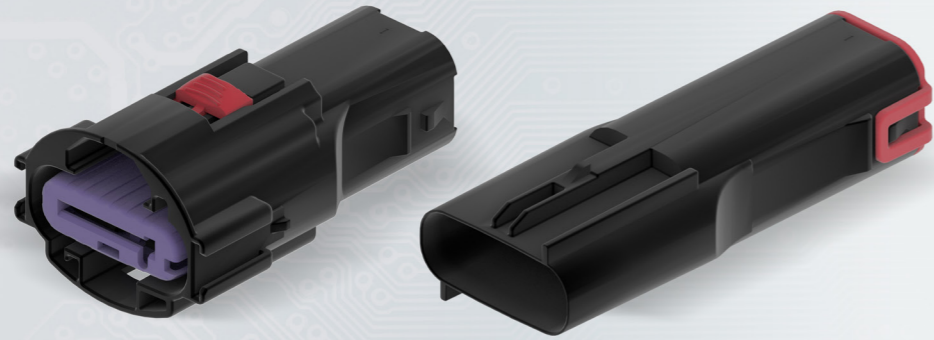

## BENEFITS

- High current carrying capacity
- PP 2000 proven terminal system
- Compact system design
- Very few parts to assemble

## FEATURES

- Up to 35 mm<sup>2</sup> cross sections
- For applications with needs up to 210A
- Silver-plated multi-contact terminal system
- Ultrasonic weld connection for higher amperage performances

## APPLICATIONS

48V Applications: High-current harnesses and devices

## PERFORMANCE

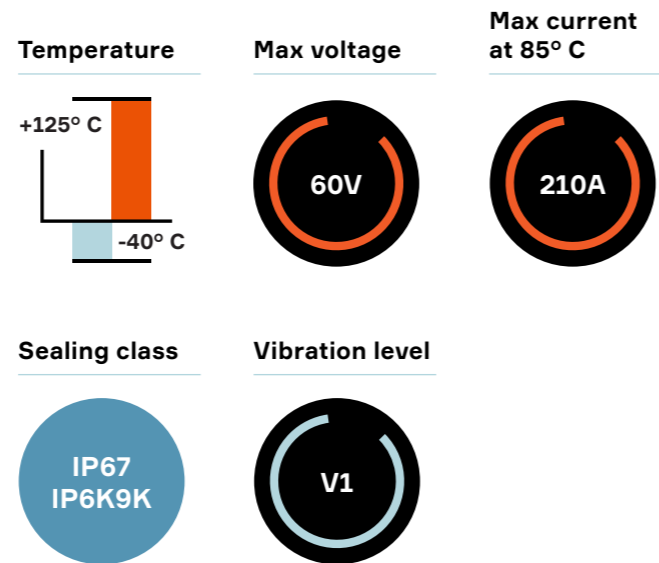

## AVAILABLE CONFIGURATIONS

Connector Type	Wire-to-device
Cable Exit Orientation	180°
Cable Range (mm <sup>2</sup> )	16, 25, 35
Terminal Type	17.7 mm blade contact
Number of Cavities	1
Assembly Assurance	CPA
Number of Code Indexes	2

Index	Inline Male Connector	Inline Female Connector	BOM
101	35191198	35191203	1
102	35191202	35191204	

## ASSOCIATED PARTS

Part Number			Description	BOM
16 mm <sup>2</sup> Cable	25 mm <sup>2</sup> Cable	35 mm <sup>2</sup> Cable		
<b>Inline male connector</b>				
	3 5228529		PP 2000 180° Sonic Weld Male Terminal	1
35191210	35191211	35191212	Cable Seal	1
35191213	35191214	35191215	Seal Retainer	1
<b>Mating connector</b>				
	13815981		PP 2000 180° Sonic Weld Female Terminal	1
35191210	35191211	35191212	Cable Seal	1
35191213	35191214	35191215	Seal Retainer	1

## DIMENSIONS MEASUREMENT SAMPLE

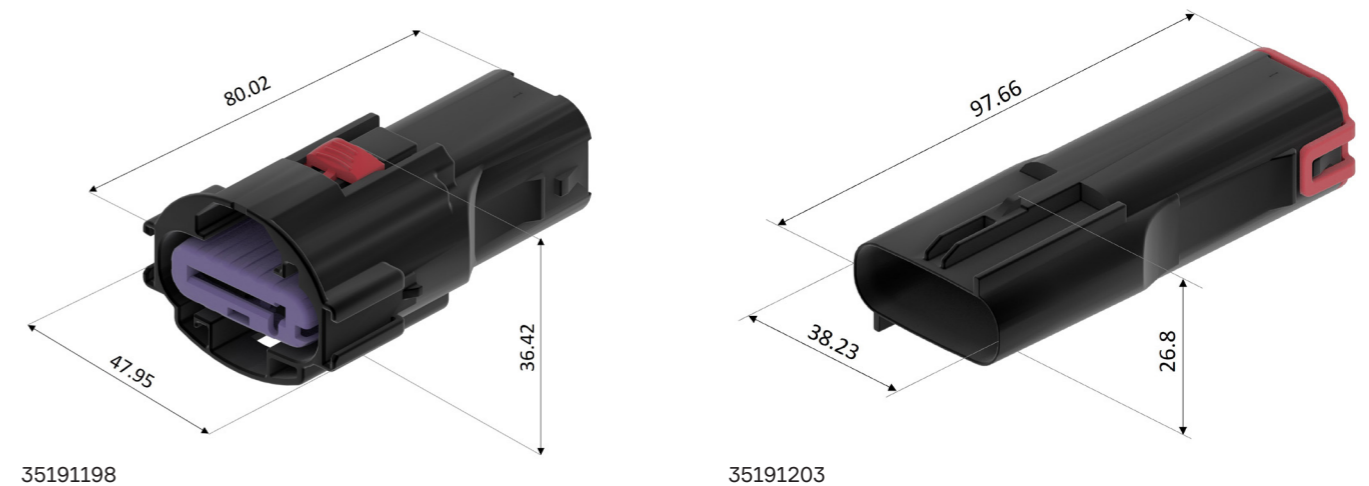







# FOR MORE INFORMATION

Visit our website: [www.aptiv.com](http://www.aptiv.com)

Browse our e-catalog: [www.aptiv.com/en/solutions/connection-systems](http://www.aptiv.com/en/solutions/connection-systems)

Contact your local distributor:

