

AK-2 SPRING LOCK SQUIB CONNECTORS

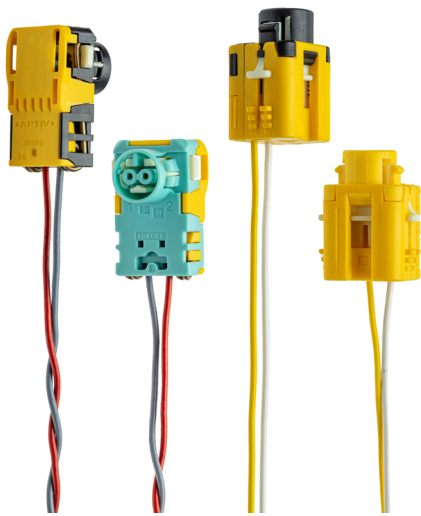

BENEFITS

- Simplified mating monitoring via spring and push out function
- Protected CPA* inside of the connector
- Good mating feedback
- Automated section side crimping available

FEATURES

- 100% scoop-proof interface and excellent blind mating characteristics
- Robust and ergonomic design
- 3 codings compatible with retainers according to ISO 19072-4 and USCAR 999-U-002-1-Z03
- Compatible with initiator according to ISO 19072-1 and USCAR 999-U-002-1-Z02



TECHNICAL CHARACTERISTICS

Interface	AK-2
Serviceability	Serviceable
EMI Filtering Device	Ferrite
Locking Type	Spring Lock CPA*
Termination Technology	Welding

* Connector Position Assurance



TEMPERATURE

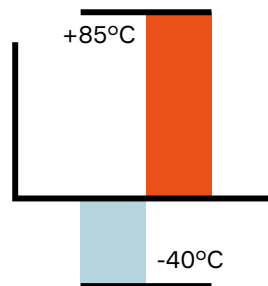

CONTACT RESISTANCE

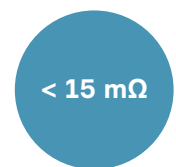

APPLICATIONS

Passenger compartment

See back page for representative part numbers and packaging dimensions.



DIELECTRIC TEST



PULL-OUT FORCE



About Aptiv

Aptiv is a global technology company that develops safer, greener and more connected solutions enabling a more sustainable future of mobility.

Visit [aptiv.com](https://www.aptiv.com) →



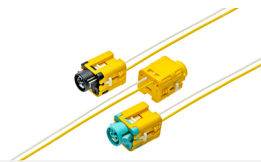

Product code	FPL90-2	FPL180-1
Interface	AK-2	AK-2
Available codings	I, II, III	I, II, III
Compatible wire size	0.35 mm ² , 0.5 mm ² , 0,75 mm ²	0.35 mm ² , 0.5 mm ² , 0,75 mm ²

For the matching part numbers, please contact your Aptiv representatives.

DIMENSION MEASUREMENT SAMPLE

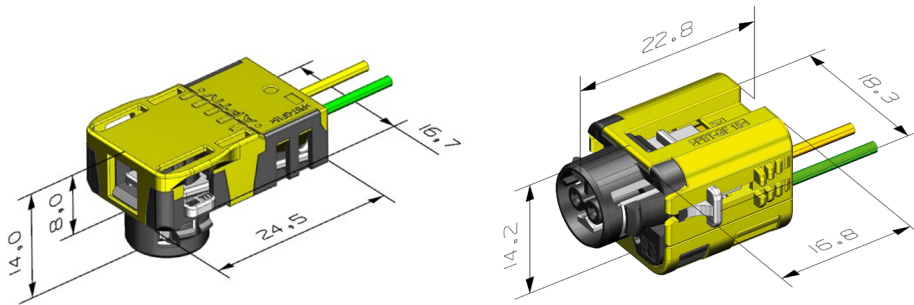

The dimensions are in mm.

MATES WITH

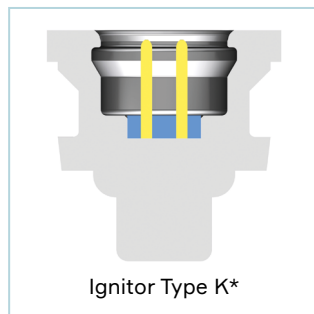
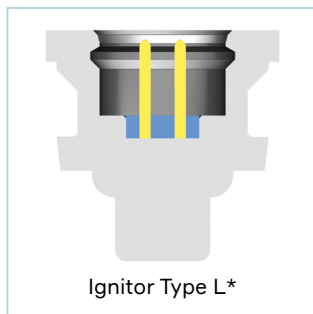

* Ignitors are not manufactured by Aptiv, please contact your usual supplier.

Part numbers, specifications, dimensions and performance data in this document are for general references only and are subject to change without notice. To verify product information, please contact an Aptiv representative.